

# Nakamichi

# CR-2/CR-1

2 Head Cassette Deck

Owner's Manual  
Bedienungsanleitung  
Mode d'Emploi

This Owner's Manual covers the following models:  
Diese Bedienungsanleitung gilt für die folgenden Modelle:  
Le mode d'emploi couvre les modèles suivants:

CR-2 CR-2A CR-2E  
CR-1 CR-1A CR-1E



English from page 3      Deutsch von Seite 10      Français de la page 17

**Congratulations!**

You have chosen a truly exceptional product. All Nakamichi audio components are created according to a simple but highly demanding philosophy: perfectly natural reproduction of the musical experience, without the slightest trace of coloration. Even the ambience of the stage and the heartbeat of the performers can be felt when hearing music reproduced the Nakamichi way. This is what has earned our products a dedicated following among discerning audio enthusiasts, music lovers and musicians the world over.

The CR-2/CR-1 cassette deck incorporates many aspects of the sophisticated technology developed for Nakamichi's upper-range models. In a simple and compact package, this deck delivers sound quality that rivals many of its peers. Specifications are guaranteed, as each deck is painstakingly adjusted at the factory. Outstanding basic recording and playback performance is complemented by attractive design and exceptional ease of use.

In order to take full advantage of this unit's superior performance, please read this manual in its entirety and retain it for future reference.

Thank you.  
Nakamichi Corporation

The photo on this page shows the concert hall in the Nakamichi Research Institute. Here every component must prove itself, above and beyond technical specifications. This hall helps us explore the realm of live music, which is the starting and end point in the development of all Nakamichi products.

**Lieber Stereofreund!**

Sie haben sich für ein in jeder Hinsicht hervorragendes Gerät entschieden. Alle Audio-Komponenten von Nakamichi folgen einem ebenso einfachen wie strikten Motto: absolut natürliche Musikwiedergabe, ohne jeden Anflug von Verfärbungen. Musik hören mit Nakamichi ist ein Erlebnis, das selbst die Raumdimension und die elektrisierende Atmosphäre auf der Bühne mit einschließt. Nicht umsonst genießt der Name Nakamichi bei Musikfreunden, HiFi-Liebhabern und Musikern auf der ganzen Welt einen so guten Ruf.

Das Cassettendeck CR-2/CR-1 basiert auf dem technischen Know-how von Nakamichis Spitzenmodellen. In der Klangqualität läßt sich dieses unkomplizierte und kompakte Gerät ohne weiteres einer hohen Klasse zuordnen. Die Beibehaltung der Leistungswerte wird durch individuelle Justierung und Einmessung im Werk garantiert. Ansprechendes Styling und ausgezeichnete Bedienungsfreundlichkeit sind weitere wichtige Merkmale.

Um die vorzügliche Leistung dieses Geräts voll zu nutzen, raten wir Ihnen, die Bedienungsanleitung vor Inbetriebnahme genau durchzulesen und für späteres Nachschlagen gut aufzubewahren.

Vielen Dank.  
Nakamichi Corporation

Das Foto auf dieser Seite zeigt die Konzerthalle im Nakamichi-Forschungszentrum. Über die rein technische Seite hinaus gewinnen wir dort wichtige Impulse für unsere Arbeit. Jedes Gerät muß hier beweisen, was in ihm steckt, und live erlebte Musik steht am Anfang und Ende aller Entwicklungsarbeit.

**Cher client!**

Vous venez d'acquérir un produit réellement exceptionnel. Tous les éléments des chaînes Nakamichi sont conçus selon un principe simple mais des plus exigeants, à savoir: une reproduction parfaitement naturelle, exempte de la moindre coloration, de toute expression musicale. Quand une musique est reproduite par Nakamichi, c'est toute l'ambiance du plateau que l'on ressent, jusqu'aux battements de coeur des musiciens. De nous être tenus à ce principe nous a valu des adeptes finès parmi les audiophiles, les mélomanes et les musiciens du monde entier.

Dans les platines à cassettes CR-2 et CR-1, on retrouve bien des aspects de la technologie de pointe appliquée aux modèles haut de gamme de Nakamichi. Résolument simples et compactes, ces platines n'en sont pas moins capables de rivaliser avec bon nombre de leurs concurrentes en matière de qualité du son. Pour la garantie des performances, les réglages en usine sont effectués avec le plus grand soin pour chaque platine prise individuellement. Ces platines ne vous offrent pas seulement une qualité incomparable en matière d'enregistrement et de lecture, elles sont également d'aspect attrayant et extrêmement facile à employer.

Afin de profiter pleinement des performances supérieures de cet appareil, nous vous conseillons vivement de lire d'abord ce mode d'emploi d'un bout à l'autre et de le conserver pour pouvoir vous y référer plus tard.

Merci.  
Nakamichi Corporation

La photo ci-dessus est une vue de la salle de concert qui se trouve dans l'institut de recherches de Nakamichi. Cette salle sert à "mesurer" les sensations qui, par définition même, sont immensurables et se situent au-delà des spécifications techniques. C'est dans ce royaume de la musique vivante que commence et qu'aboutit la création de tous les produits Nakamichi.



**CAUTION**

TO REDUCE THE RISK OF ELECTRIC SHOCK, DO NOT REMOVE COVER (OR BACK). NO USER-SERVICEABLE PARTS INSIDE.

REFER SERVICING TO QUALIFIED SERVICE PERSONNEL.



The lightning flash with arrowhead symbol, within an equilateral triangle, is intended to alert the user of the presence of uninsulated "dangerous voltage" within the product's enclosure; that may be of sufficient magnitude to constitute a risk of electric shock to persons.



The exclamation point within an equilateral triangle is intended to alert the user of the presence of important operating and maintenance (servicing) instructions, in the literature accompanying the appliance.

**WARNING**

TO PREVENT FIRE OR SHOCK HAZARD, DO NOT EXPOSE THIS APPLIANCE TO RAIN OR MOISTURE.

This equipment generates and uses radio frequency energy and if not installed and used properly, that is, in strict accordance with the manufacturer's instructions, may cause interference to radio and television reception. It has been type tested and found to comply with the limits for a Class B computing device in accordance with the specifications in Subpart J or Part 15 of FCC Rules, which are designed to provide reasonable protection against such interference in a residential installation.

However, there is no guarantee that interference will not occur in a particular installation. If this equipment does cause interference to radio or television reception, which can be determined by turning the equipment off and on, the user is encouraged to try to correct the interference by one or more of the following measures:

- reorient the receiving antenna
- relocate this equipment with respect to the receiver
- move this equipment away from the receiver
- plug this equipment into a different outlet so that equipment and receiver are on different branch circuits.

If necessary, the user should consult the dealer or an experienced radio/television technician for additional suggestions. The user may find the following booklet prepared by the Federal Communications Commission helpful:

"How to Identify and Resolve Radio-TV Interference Problems".

This booklet is available from the U.S. Government Printing Office, Washington, DC 20402, Stock No. 004-000-00345-4.

Please record the Model Number and Serial Number in the space provided below and retain these numbers.

Model Number and Serial Number are located on the rear panel of the unit.

Model Number: CR-2/CR-1  
CR-2A/CR-1A  
CR-2E/CR-1E

Serial Number: \_\_\_\_\_

Nakamichi high-fidelity equipment is sold in more than 50 countries around the world. Many of these countries have strict safety regulations to which Nakamichi products must comply.

Models designated by an "A" have been produced for North America (USA and Canada) and comply with the requirements of Underwriters Laboratories (UL) and/or Canadian Stan-

dards Association (CSA) as well as with other applicable state/provincial and federal safety standards.

Models designated by an "E" have been produced for Europe and comply with the requirements of EEC Recommendation 82/499 as well as with other applicable European safety standards.

Models without an "A" or "E" have been produced for countries other than North America, Europe and Japan and comply with applicable safety standards.

Nakamichi has authorized its local distributors to offer warranties only on products which have been produced in accordance with the foregoing standards.

**Safety Instructions**

The following safety instructions have been included in compliance with safety standard regulations. Please read them carefully.

1. Read Instructions — All the safety and operating instructions should be read before the appliance is operated.
2. Retain instructions — The safety and operating instructions should be retained for future reference.
3. Heed Warnings — Adhere to all warnings on the appliance and in the operating instructions.

4. Follow Instructions — All operating and use instructions should be followed.
5. Water and Moisture — The appliance should not be used near water — for example, near a bathtub, washbowl, kitchen sink, laundry tub, in a wet basement, or near a swimming pool, etc.
6. Carts and Stands — The appliance should be used only with a cart or stand that is recommended by the manufacturer.
7. Wall or Ceiling Mounting — The appliance should be mounted to a wall or ceiling only as recommended by the manufacturer.

8. Ventilation — The appliance should be situated so that its location or position does not interfere with its proper ventilation. For example, the appliance should not be situated on a bed, sofa, rug or similar surface that may block the ventilation openings; or placed in a built-in installation, such as a bookcase or cabinet that may impede the flow of air through the ventilation openings.
9. Heat — The appliance should be situated away from heat sources such as radiators, heat registers, stoves, or other appliances (including amplifiers) which produce heat.

10. Power Sources — The appliance should be connected to a power supply only of the type described in the operating instructions or as marked on the appliance.
11. Grounding or Polarization — Precautions should be taken so that the grounding or polarization means of an appliance is not defeated.
12. Power-Cord Protection — Power-supply cords should be routed so that they are not likely to be walked on or pinched by items placed upon or against them, paying particular attention to cords at plugs, convenience receptacles, and the point where they exit from the appliance.
13. Cleaning — The appliance should be cleaned only as recommended by the manufacturer.
14. Nonuse Periods — The power cord of the appliance should be unplugged from the outlet when left unused for a long period of time.
15. Object and Liquid Entry — Care should be taken so that objects do not fall and liquids are not spilled into the enclosure through openings.
16. Damage Requiring Service — The appliance should be serviced by qualified service personnel when:
  - A. The power-supply cord or the plug has been damaged; or,
  - B. Objects have fallen, or liquid has been spilled into the appliance; or
  - C. The appliance has been exposed to rain; or,
  - D. The appliance does not appear to operate normally or exhibits a marked change in performance; or,
  - E. The appliance has been dropped, or the enclosure damaged.
17. Servicing — The user should not attempt to service the appliance beyond that described in the operating instruction. All other servicing should be referred to qualified service personnel.

## Connections

Switch the power to all components OFF. Then use the supplied shielded cables with RCA-type plugs to establish connections as shown in the chart. As this deck has only line input facilities, a separate microphone mixer with line-level outputs must be used for microphone recordings. Connect the output of the mixer to the deck's "Line Input" jacks. Nakamichi offers the optional MX-100 Microphone Mixer, which provides three microphone inputs. To power the MX-100, the separate PS-100 Power Supply is required.

### System Remote Terminal (CR-2)

This terminal can be connected either to the wired remote control unit RM-5 or a Nakamichi component equipped for system remote control (such as the CA-7). For details, please refer to the Owner's Manual of the respective component.

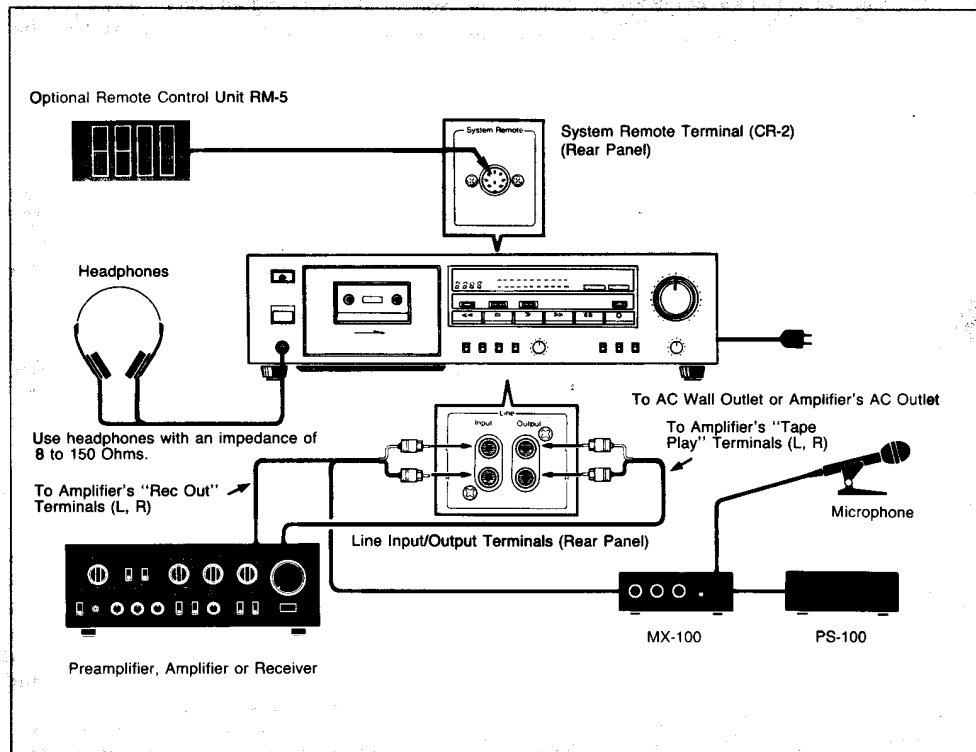

## Helpful Hints

- This cassette deck incorporates a muting circuit which operates for about 4 seconds after the power was switched on. During the muting interval, the tape transport buttons are inactive.
- If the power to the deck is switched off while the tape is running, it may not be possible to open the cassette holder. Do not apply excessive force in such a case. Set the Timer switch to "Off," and then switch the power to the deck back on. The cassette can now be removed.
- For reasons of reliability and performance, C-120 cassettes are not recommended for music recording.
- Cassette tapes have tabs to prevent accidental

erasure. When these tabs are removed, the deck does not enter the record mode even if the Record button is pressed. If you wish to record over a side for which the tab has been removed, cover the tab opening with a piece of adhesive tape.

### Voltage Selector

- The "127 V" position of this deck's voltage selector permits use of the deck in areas with AC line voltages from 120 to 127 volts.
- Safety regulations in certain countries prohibit inclusion of a voltage selector. This feature, therefore, may be absent from your deck.

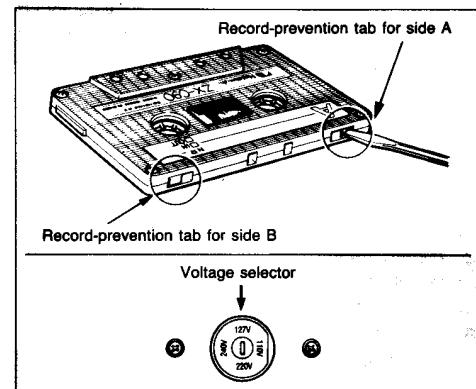

# Controls and Features

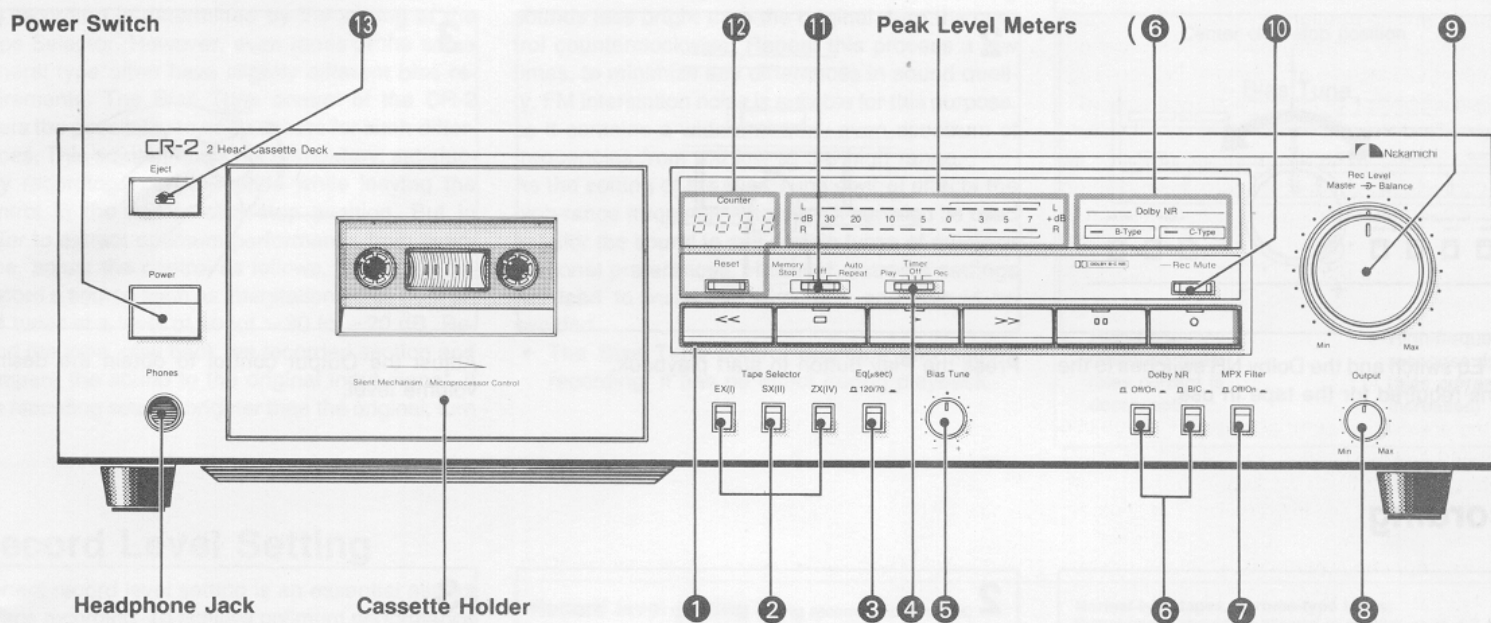

The illustration shows the CR-2.

## 1 Tape Transport Buttons

From the left, these buttons control Rewind, Stop, Play, Fast-Forward, Pause, and Record. To restart the tape from the pause mode, press the Play button. With this deck, the record/pause (recording standby) mode is activated simply by pressing the Record button.

## 2 Tape Selector

Before recording, the correct button must be pressed for the tape in use. The EX (I) button is for normal-type tapes, the SX (II) button for chrome-type tapes and the ZX (IV) button for metal tapes. In playback, the Tape Selector has no effect and can be set to any position.

## 3 Eq Switch

This switch serves to select the proper equalization for each tape in recording and playback. In regular use, normal-type tapes should be used at the 120  $\mu$ s position and chrome-type and metal tapes at the 70  $\mu$ s position. As the Eq and Tape Selectors are separate on Nakamichi cassette decks, different combinations to suit special requirements are also possible. (→ page 7)

## 4 Timer Switch

This switch is used for timer-activated recording or playback. In ordinary operation, it must be set to "Off." (→ page 6)

## 5 Bias Tune Control (CR-2)

Used for fine adjustment of the recording bias current. (→ page 7)

## 6 Dolby NR Switches and Indicators

To activate the Dolby noise reduction system in recording or playback, set the left switch to "On" and select either the B-type or the C-type system with the right switch. Playback must be carried out at the same setting as used in recording. The Dolby NR indicators show which system is selected.

## 7 MPX Filter Switch

This switch serves to suppress remnants of the 19-kHz multiplex carrier signal, which could interfere with proper Dolby NR operation when recording from FM stereo broadcasts. Most modern tuners incorporate filters which reliably remove the carrier, so that problems during recording are unlikely, even when the MPX Filter switch of this deck is set to "Off." If an audible degradation of the recorded sound is noticed, set the switch to "On."

## 8 Output Level Control (CR-2)

Serves to adjust the line output and headphone listening level.

## 9 Rec Level/Balance Controls

The inner knob of this concentric control adjusts the input level and the outer knob the left/right channel balance during recording. Except when there is a noticeable left/right level difference in the program source, only the Rec Level control needs to be adjusted.

## 10 Rec Mute Button (CR-2)

During recording, the recording signal is cut off as long as the button is depressed. This is useful to insert blank spaces between selections.

## 11 Memory Stop/Repeat Switch

This switch has two functions.  
**Memory Stop** (left position): When the switch is in this position, the tape stops automatically during fast-forward or rewind when the zero point of the tape counter is reached (CR-1: during rewind only). By resetting the counter to zero at a specific location, that point can be easily found afterward.

**Auto Repeat** (right position): Setting the switch to this position during playback, recording, fast-forward or rewind activates auto repeat. When the tape end is reached, the cassette is automatically rewound and playback starts again from the beginning. In this way, playback of the current cassette side is automatically repeated.

## 12 Tape Counter

Shows the tape position in four-digit numbers. Pressing the Reset button returns the indication to zero.

- The tape counter of the CR-1 has three digits.

## 13 Eject Button

Press to open the cassette holder.

## Playback

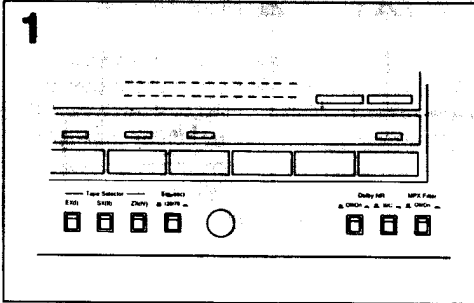

1 Set the Eq switch and the Dolby NR switches to the positions required for the tape in use.

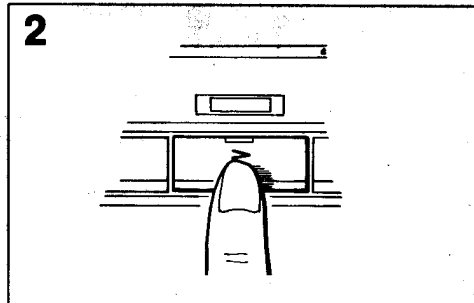

2 Press the Play button to start playback.

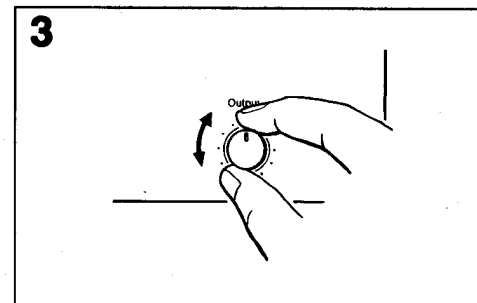

3 Adjust the Output control to obtain the desired volume level.

## Recording

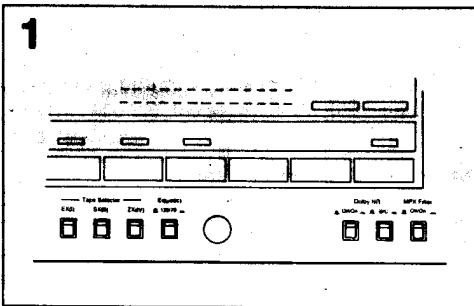

1 Set the Tape Selector and the Eq switch to the positions required for the tape. Select the desired noise reduction system with the Dolby NR switches.

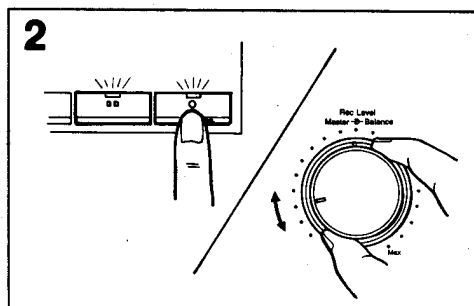

2 Press the Record button to set the deck to the record/pause (recording standby) mode. Now adjust the recording level and balance with the Rec level and Balance controls, while watching the indication of the peak level meters.

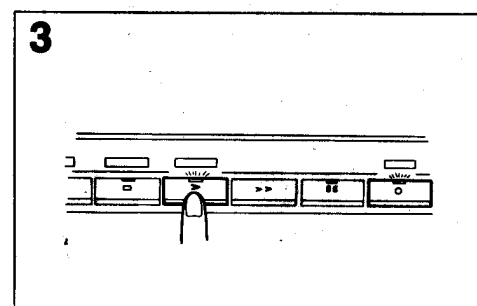

3 Pressing the Play button in this condition starts recording. For short-term interruptions, press the Pause button. The deck reverts to the record/pause condition. To resume recording, press the Play button again.

## Timer Recording or Playback

By using a separate audio timer, unattended recording or automatic playback can be easily carried out. Be sure to set the deck's Timer switch to "Off" when this feature is not desired. If the switch is left in the "Rec" or "Play" position and power to the deck is turned on, the respective function will be activated and an inserted cassette may be erased inadvertently.

1. Set up the amplifier, tuner etc. as for normal recording or playback. Then set the Timer switch of the cassette deck to the desired function ("Rec" or "Play").
2. Set the timer to the desired switch-on and switch-off time.
3. At the pre-selected time, the timer will supply power to the components and recording or playback will start automatically.

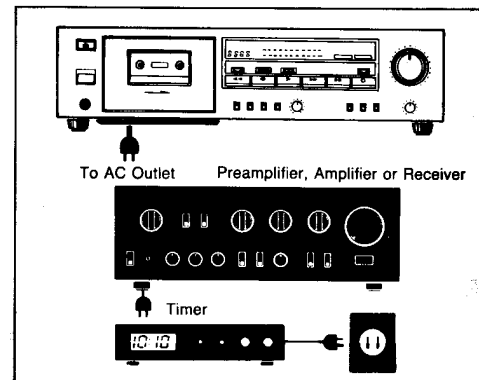



## Cleaning

It is very important to regularly clean the head surfaces, capstans, pressure rollers, etc. Contamination caused by tiny particles shed from the tape onto these parts can become the cause of dropouts and severely degrade high-frequency response and wow-and-flutter characteristics. Perform cleaning about once every 10 hours of use. Cotton swabs lightly moistened with zero-residue, fluorocarbon-based fluid are an economical, effective and safe

tool for this task.

- The head assembly, tape guides and other parts of this deck's tape transport are critically aligned. Be careful not to apply too much force during cleaning.

## Demagnetization

After a longer period of use, residual magnetism can build up in the heads and capstans, which leads to

noise and can partially erase the high frequencies of a tape being played. To prevent this, you should demagnetize these parts about once every 50 hours of use with the Nakamichi DM-10 demagnetizer (optional) or any other properly designed demagnetizer. For details, please refer to the instruction manual of the demagnetizer.

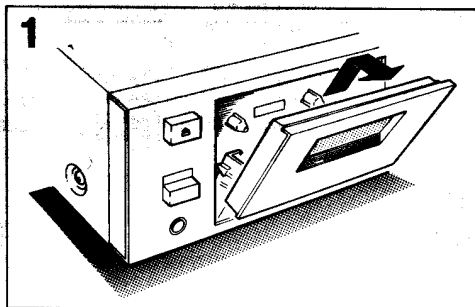

Press the Eject button and remove the cassette holder cover.

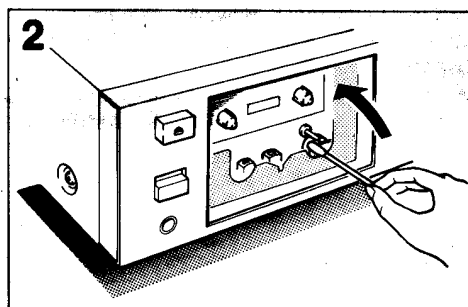

Push the cassette holder back in, switch the deck on and press the Play button. Clean the revolving pressure roller by holding a cotton swab lightly against the roller on the side turning away from the capstan. Take care that the cotton swab does not get caught between the roller and the capstan.

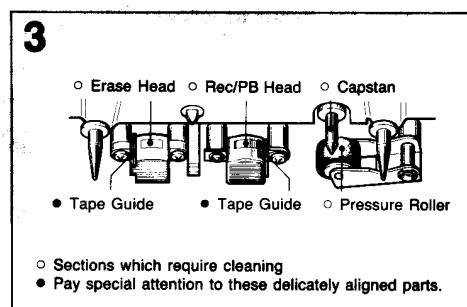

Press the Pause button to release the pressure roller from the capstan. Now clean the capstan and the surfaces of the heads and tape guides. Finish by using a dry cotton swab, and make sure that no cotton strands are left on any of the cleaned parts.

## Troubleshooting

### [Tape transport]

- **Tape does not run.**
  - ▷ Close the cassette holder firmly.
- **In rewind, the tape stops before the tape start is reached, or fluctuates between playback and rewind.**
  - ▷ Set Memory Stop/Repeat switch to "Off."
- **Playback or recording starts when deck is switched on.**
  - ▷ Set Timer switch to "Off."

### [Recording, playback]

- **Recording or playback is not possible.**
  - ▷ Check switch settings and connections of all components.
  - ▷ Adjust Output Level (CR-2) and Rec Level controls.
- **Dull high frequencies, unnatural sound.**
  - ▷ Perform head and transport cleaning.
  - ▷ Check for correct settings of Bias control (CR-2), Tape Selector, Eq switch, Dolby NR switches.

- **Uneven sound levels, dropouts, excessive wow/flutter.**
  - ▷ Perform head and transport cleaning.
- **Induction noise (hum) is heard.**
  - ▷ Keep deck and connecting cables away from amplifiers, TV sets, fluorescent lamps, etc.



## Specifications

Track Configuration .....	4 tracks/2-channel stereo	Erase .....	Better than 60 dB (100 Hz, +10 dB)
Heads .....	2 (erase head × 1, record/playback head × 1)	Separation .....	Better than 36 dB (1 kHz, 0 dB)
Motors .....	DC servo motor (capstan drive) × 1	Crosstalk .....	Better than 60 dB (1 kHz, 0 dB)
	DC motor (reel drive × 1, cam drive × 1)	Bias Frequency .....	105 kHz
Power Source .....	120, 220, 240 or 110/127/220/240 V AC, 50/60 Hz	Input (Line) .....	50 mV/30k ohms
	(According to country of sale)	Output (Line) .....	0.5 V (400 Hz, 0 dB) (CR-2: Output level control at max.)
Power Consumption .....	CR-2: 30 W max.		2.2k ohms
	CR-1: 25 W max.	(Headphones) .....	CR-2: 2.2 mW into 8 ohms
Tape Speed .....	1-7/8 ips. (4.8 cm/sec.) ± 0.5%		(400 Hz, 0 dB, output level control at max.)
Wow-and-Flutter .....	Less than 0.11% WTD Peak		CR-1: 1.2 mW into 8 ohms (400 Hz, 0 dB)
	Less than 0.06% WTD RMS	Fast-Wind Time .....	Approx. 80 seconds (with C-60 cassette)
Frequency Response .....	20 Hz—20,000 Hz ± 3 dB	Dimensions .....	430 (W) × 100 (H) × 265 (D) mm
	(recording level — 20 dB, ZX[Type IV], SX[Type II],		16-15/16 (W) × 3-15/16 (H) × 10-7/16 (D) inches
	EXII [Type I] tape)	Approximate Weight .....	5.4 kg, 11 lbs. 14 oz
Signal-to-Noise Ratio .....	Dolby C-Type NR on < 70 μs, ZX[Type IV] tape >		
	Better than 70 dB (400 Hz, 3% THD, IHF A-WTD RMS)		
	Dolby B-Type NR on < 70 μs, ZX[Type IV] tape >		
	Better than 64 dB (400 Hz, 3% THD, IHF A-WTD RMS)		
Total Harmonic Distortion ...	Less than 1.0% (400 Hz, 0 dB, ZX[Type IV], SX[Type II],		
	EXII[Type II] tape)		

- Specifications and design are subject to change for further improvement without notice.
- Noise Reduction System manufactured under license from Dolby Laboratories Licensing Corporation.
- The word "DOLBY" and the Double-D-Symbol are trademarks of Dolby Laboratories Licensing Corporation.